



z-moulds®

INSPIRING PARTNER

PETinar Series

Tethered Caps: Design, Produce and Inspect!

March 24th, 2022



A SHORT INTRODUCTION

GENERAL COMPANY INFO



z-werkzeugbau[®]

KOMPETENT PROFESSIONELL BEGEISTERND

Dr.-Walter-Zumtobel-Str. 9

6850 Dornbirn / Austria

+43 5572 7272-0









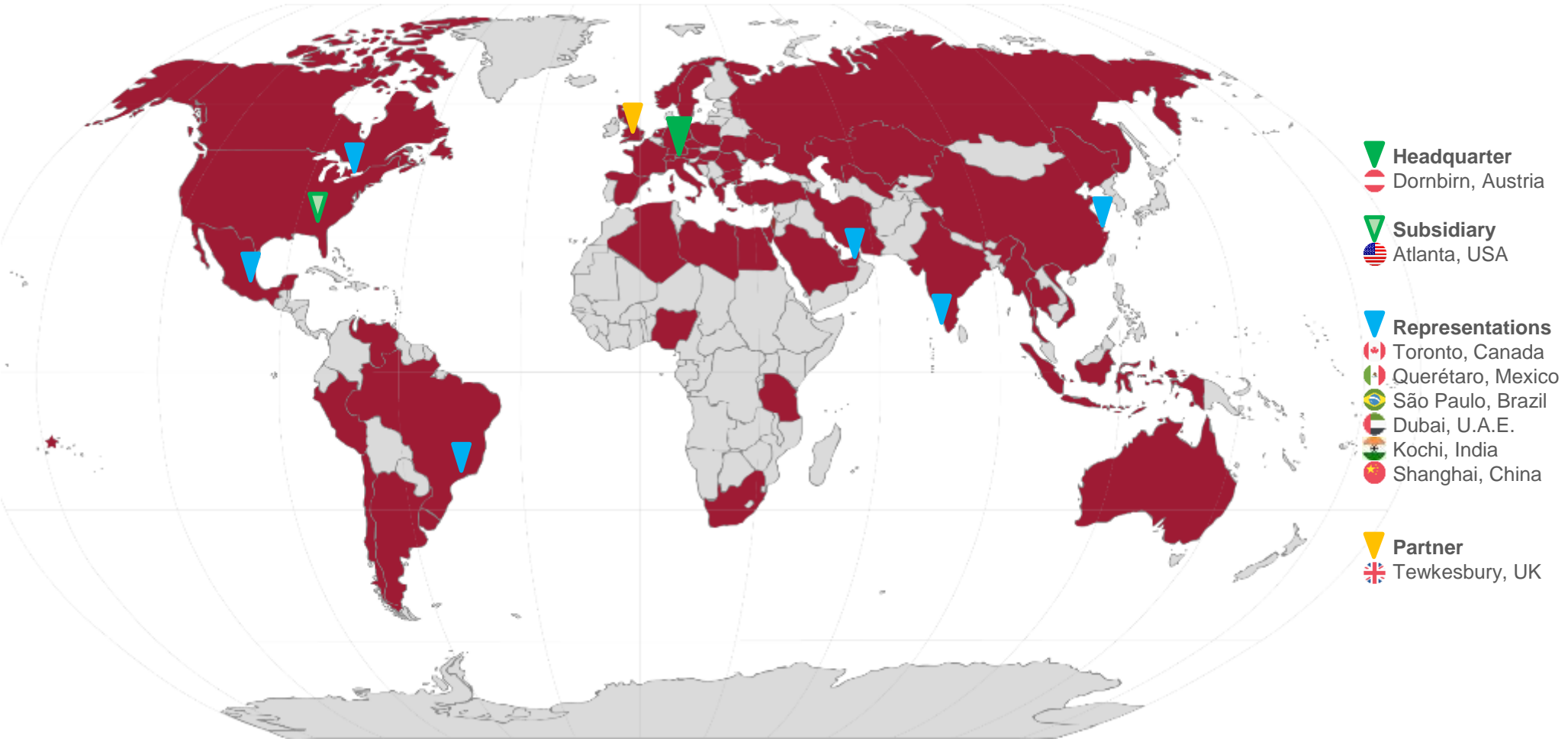



www.z-werkzeugbau.com

- ✓ PRIVATE OWNED COMPANY WITH LEAN MANAGEMENT
 - ✓ SUSTAINABLE BUSINESS STRATEGY
 - ✓ TECHNOLOGY & INNOVATION LEADERS
 - ✓ FAST DECISION-MAKING PROCESSES
 - ✓ FLEXIBLE & HIGHLY MOTIVATED TEAM
 - ✓ EXPERT KNOWLEDGE FOR CLOSURES & MOULDS
- ... YOUR INSPIRING PARTNER !**



OUR INTERNATIONAL PRESENCE



-  **Headquarter**
Dornbirn, Austria
-  **Subsidiary**
 Atlanta, USA
-  **Representations**
 Toronto, Canada
 Querétaro, Mexico
 São Paulo, Brazil
 Dubai, U.A.E.
 Kochi, India
 Shanghai, China
-  **Partner**
 Tewkesbury, UK

CAP SPECIALIST



WE UNDERSTAND YOUR BUSINESS

As a caps and closure specialist, we deliver complete solutions. Starting from new closure design ideas, the design of new products, develop and test them until your final approval and qualification.

FULLY APPROVED LABORATORY

During testing and qualification our laboratory can carry out all kind of closure tests according to global standards.



CAPS & CLOSURE
DESIGNS



CAPS & CLOSURE
DEVELOPMENT



CAPS & CLOSURE
TESTING



CAPS AND
CLOSURE LINE
SUPPORT

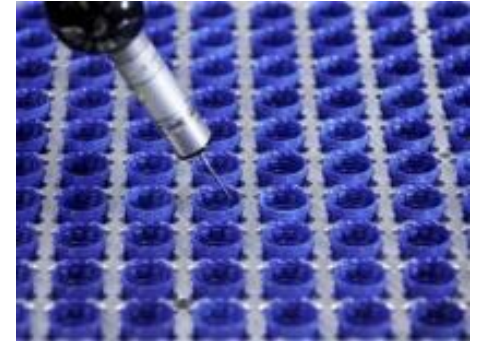

COMPETENT - PROFESSIONAL - INSPIRING



LEADING TECHNOLOGIES



✓ PATENTED SYSTEMS

We have several patented technologies that enables our customers to produce at the highest efficiency rate.

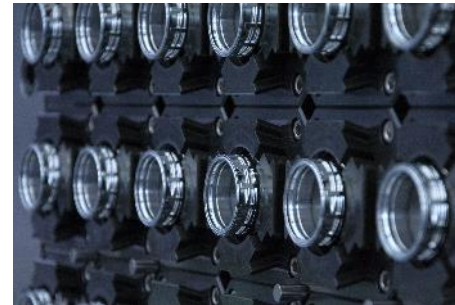

✓ HIGHEST RELIABILITY

All our moulds are designed for non-stop operation on lowest possible maintenance effort.

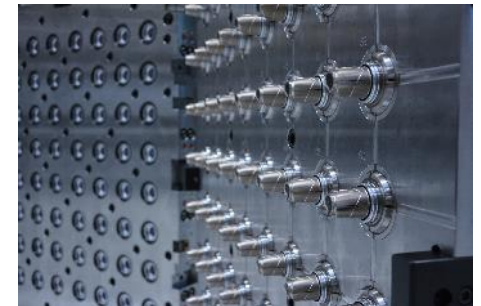
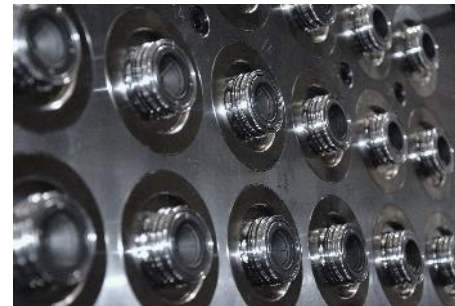

✓ SINGLE- OR MULTI-COMPONENT

Doesn't matter if single component screw-cap or multi-component flip-top our mould expertise covers the full range of applications.





A SMART WAY TO DO TETHERED CAPS

NEW CLOSURE DESIGNS WITH NEW REQUIREMENTS

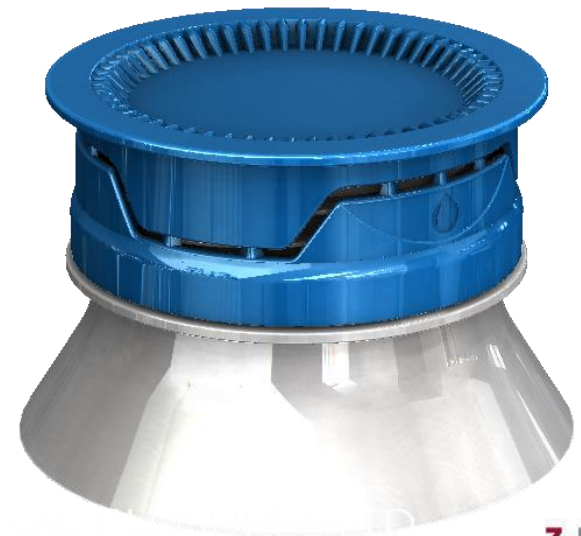

A WELL PROVEN SYSTEM – THE PATENTED Z-SLIDES®



z-slides®
PATENTED
TECHNOLOGY

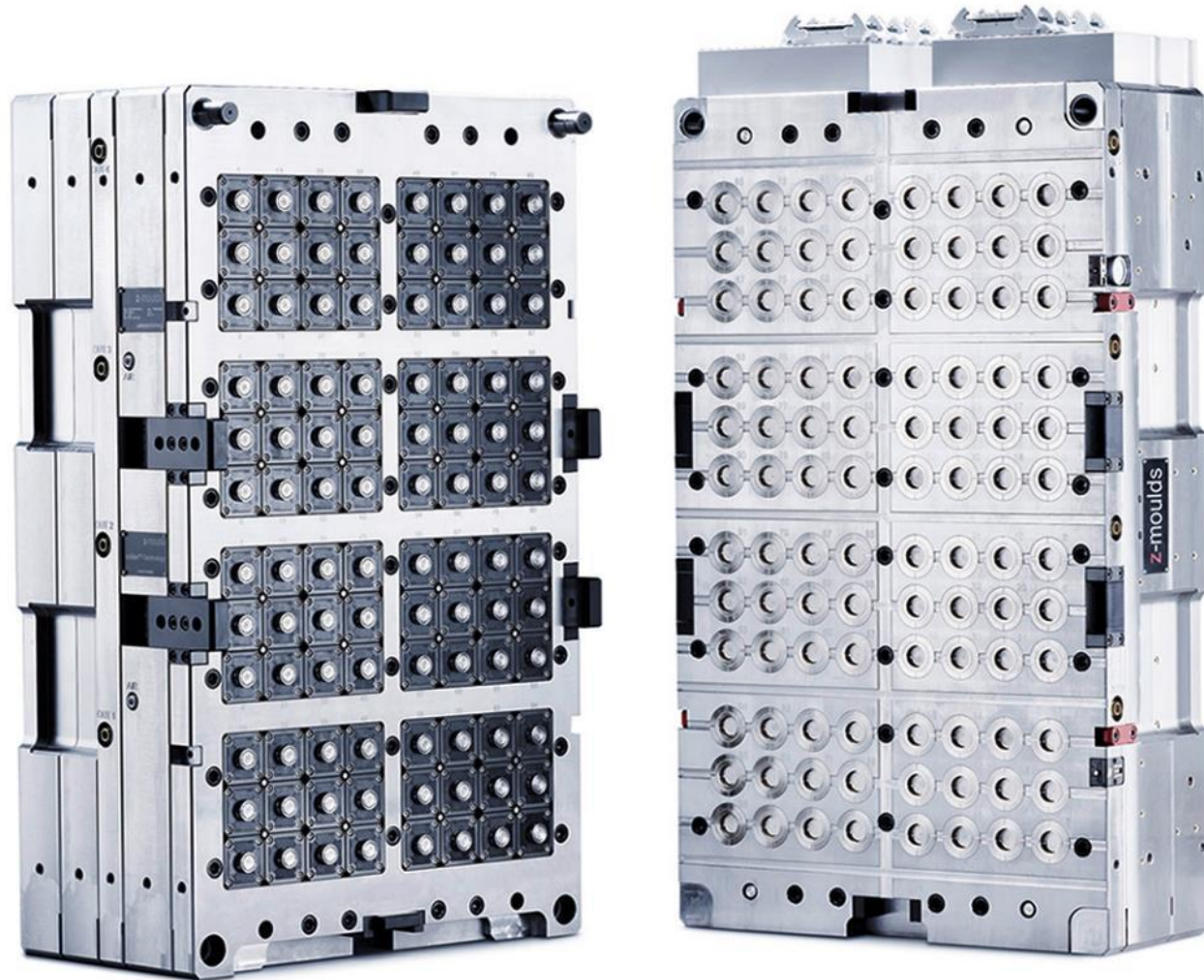

z-slides[®]
PATENTED
TECHNOLOGY



FLAT PARTING LINE

**NO CENTRING OF
CAVITIES NECESSARY**



z-slides®
PATENTED
TECHNOLOGY



z-slides[®]
PATENTED
TECHNOLOGY



z-slides®
PATENTED
TECHNOLOGY

**MOULD CENTRING ONLY
WITH GUIDING BARS**

NEARLY WEAR FREE SYSTEM

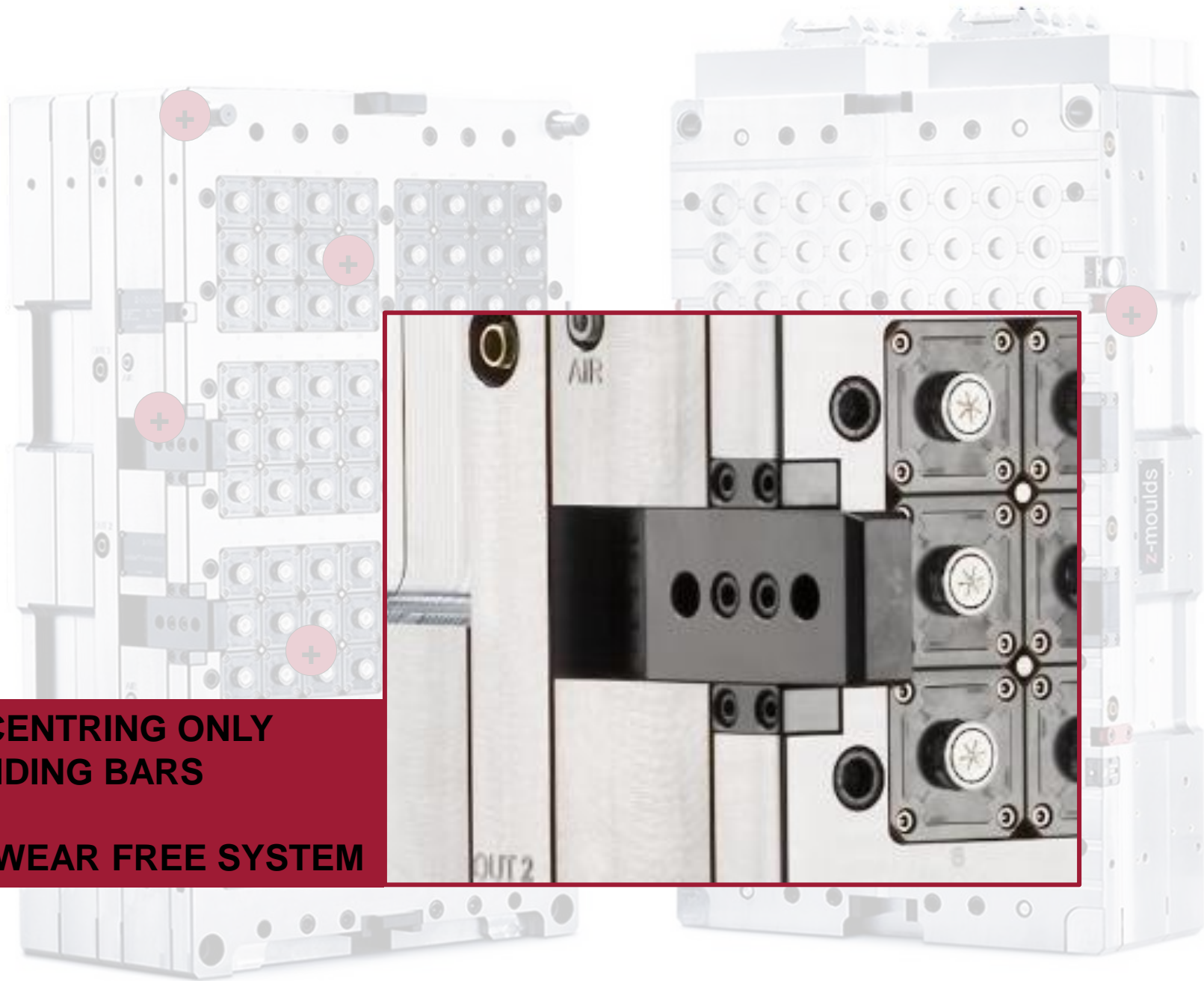

z-slides[®]
PATENTED
TECHNOLOGY



z-slides®
PATENTED
TECHNOLOGY

SINGLE CAVITIES

**ACCESSIBLE FROM
THE FRONT**

**SAME PITCH SIZE
FOR FULL RANGE
OF CLOSURES**

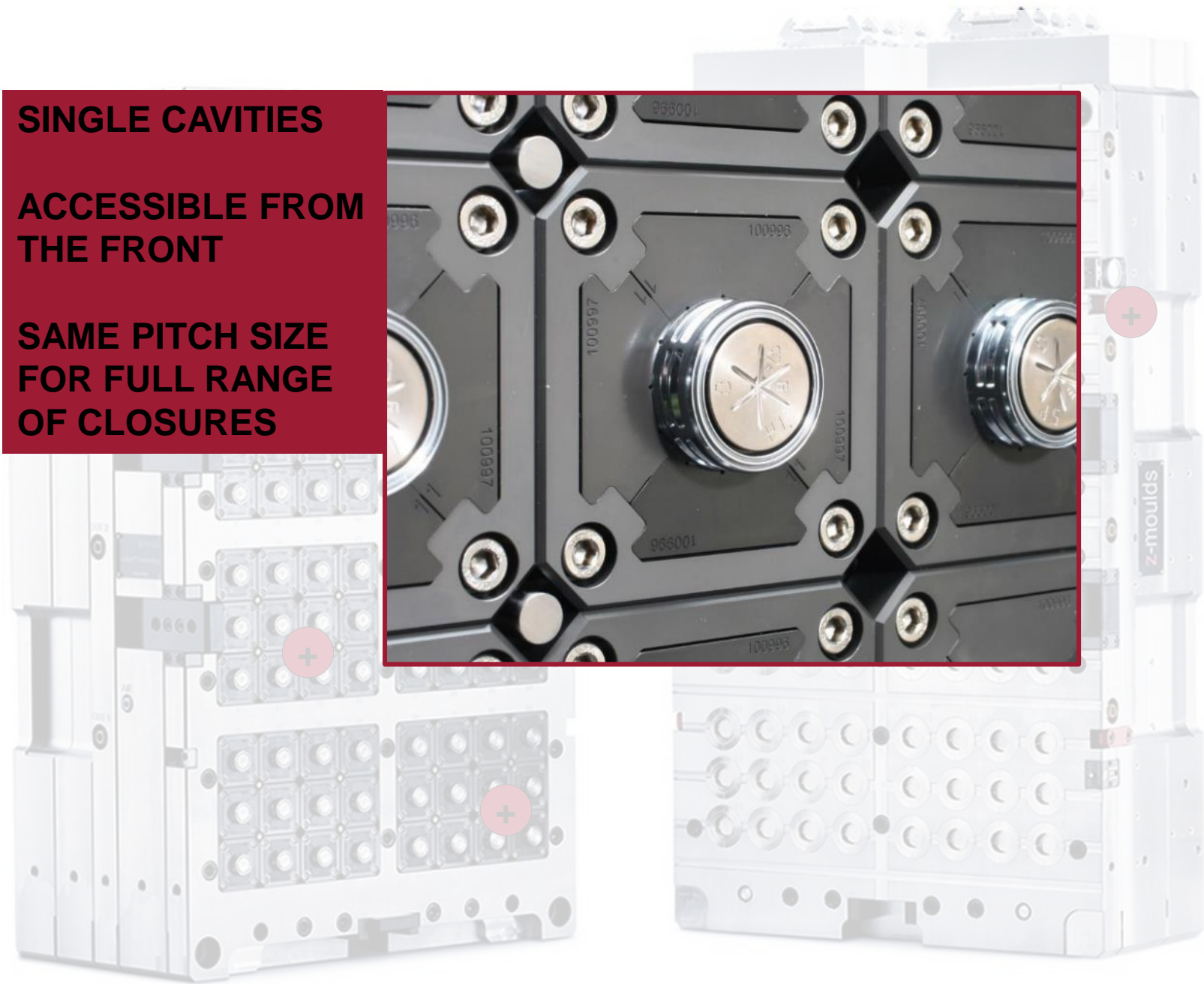

z-slides®
PATENTED
TECHNOLOGY

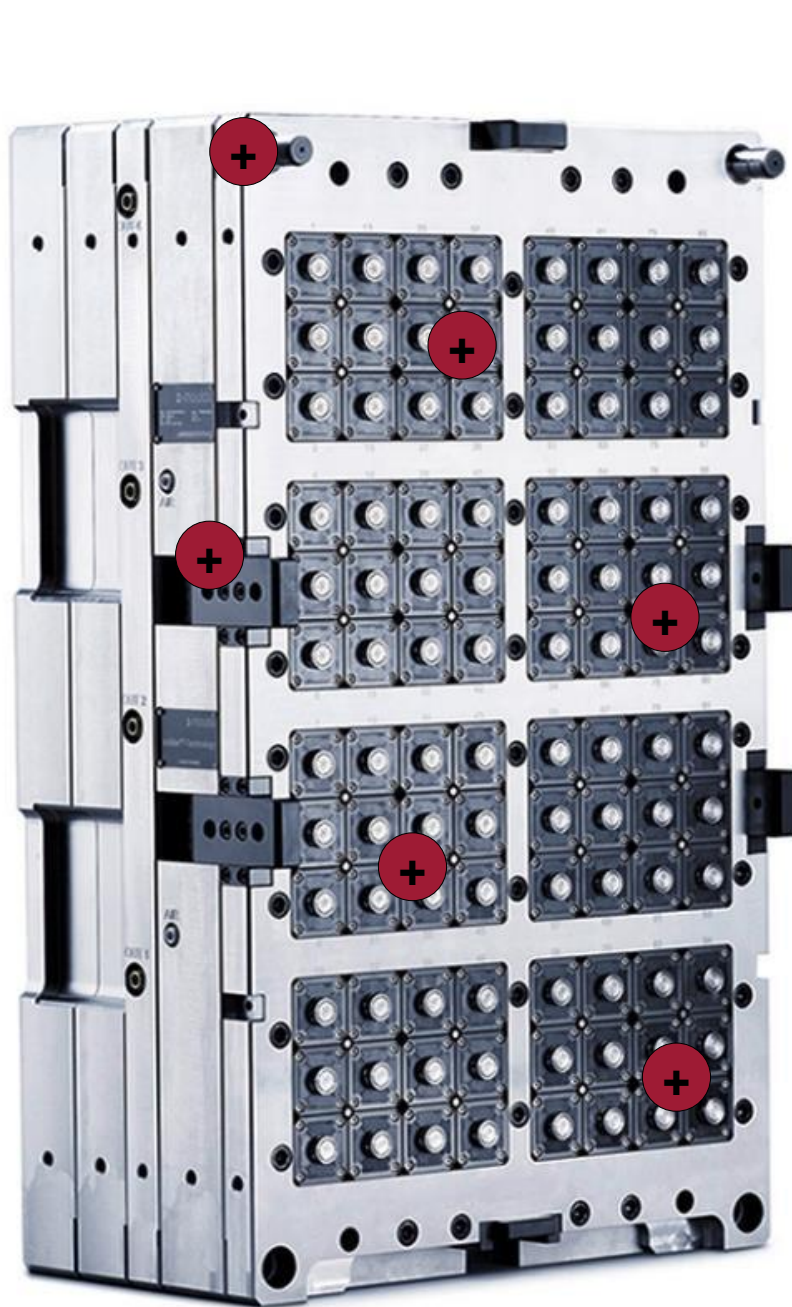

z-slides®
PATENTED
TECHNOLOGY

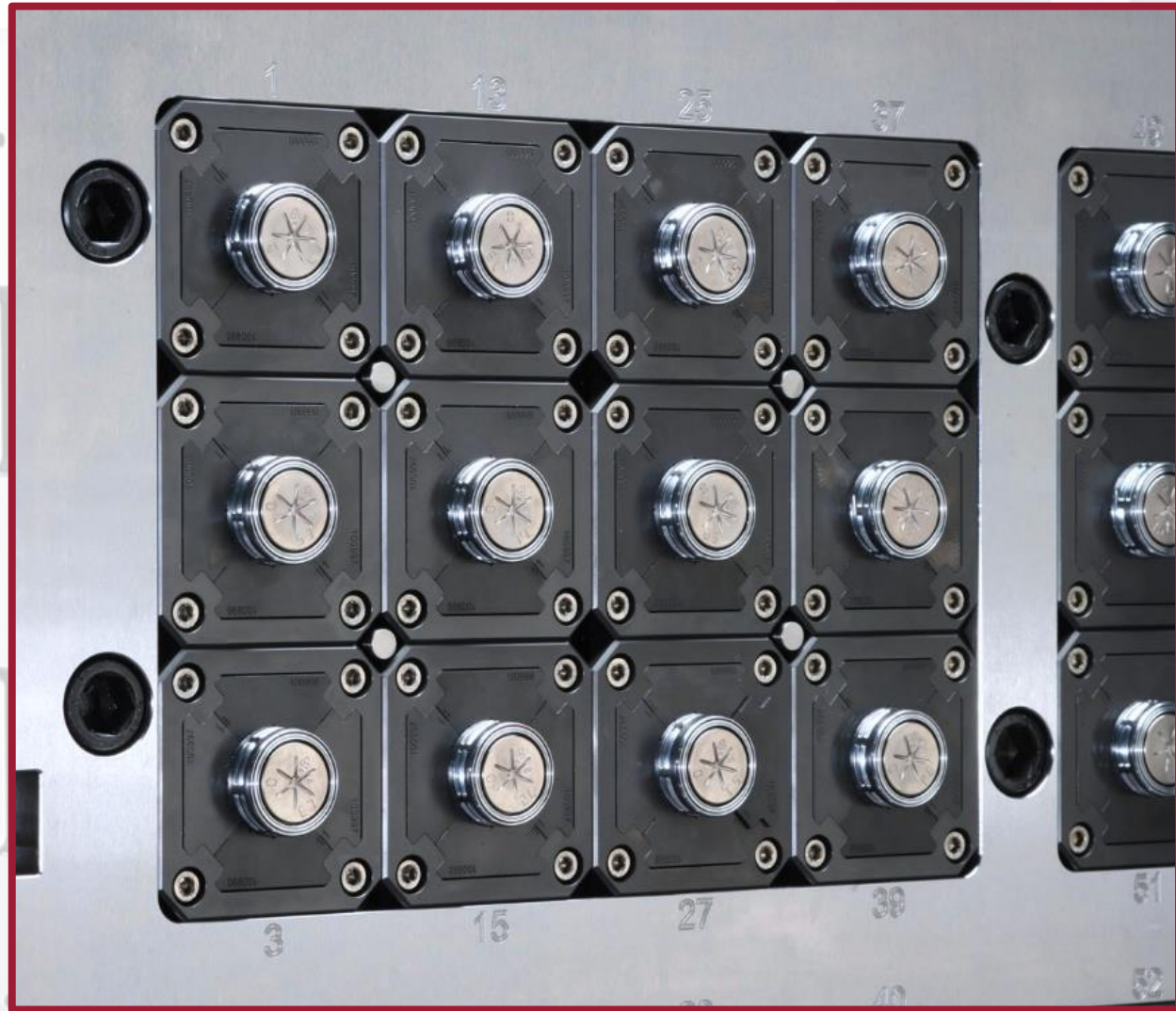

z-slides®
PATENTED
TECHNOLOGY



z-slides®
PATENTED
TECHNOLOGY



z-slides[®]
PATENTED
TECHNOLOGY



NEW REQUIREMENTS FOR TETHERED CAPS

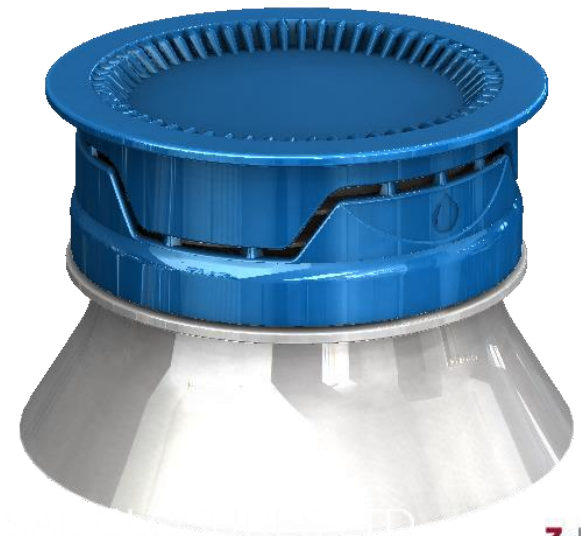

NEW REQUIREMENTS – NEW SOLUTIONS



Mould Parting Line



Up to 15mm height

GME 30.41
Regular TE-Band

GME 30.40
Tethered Cap

29/25
Tethered Cap

Z-SLIDES® EXTENDED

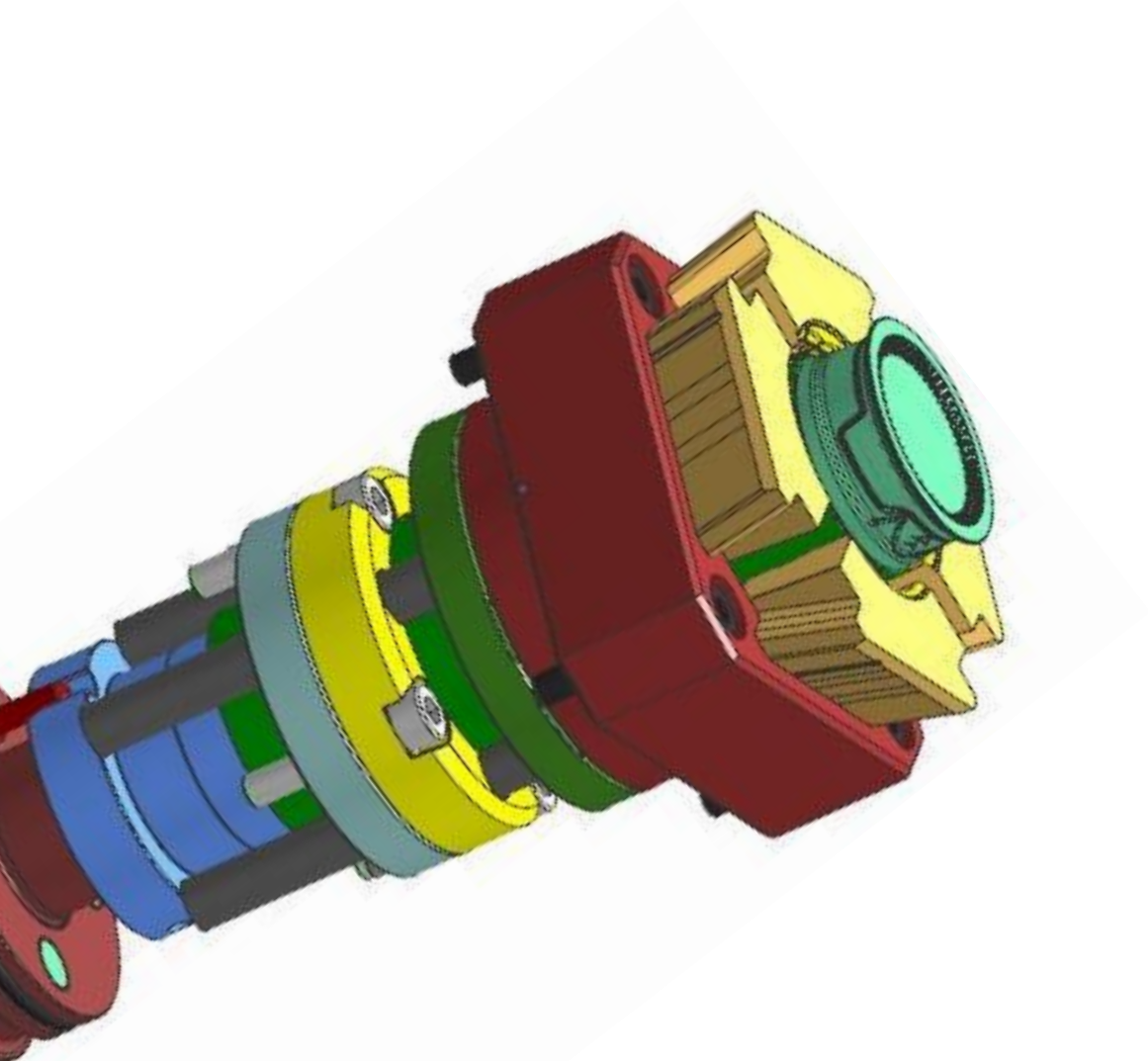



BIG RANGE OF CLOSURE DESIGNS

- Cap Outer Diameter: 25mm – 33mm
- Max Cap Height in Slider: 15mm

WIDE NECK STANDARD COMPATIBILITY

Existing necks like: PCO1881, PCO1810, 29/25mm, 30/25mm

New necks like: 26/22mm, GME30.37, GME30.38, GME30.40, GME30.41, 25mm

Z-SLIDES EXTENDED



- ✓ Well known and established system
- ✓ All advantages of patented z-slides system remain the same
- ✓ No double centring between hot and cold half
- ✓ Compact mould construction (70x70mm and 85x85mm)
- ✓ Completely modular system
- ✓ Wide compatibility to existing moulds
- ✓ Low changeover cost for new designs
- ✓ Re-use of existing moulds leads to lowest carbon food print

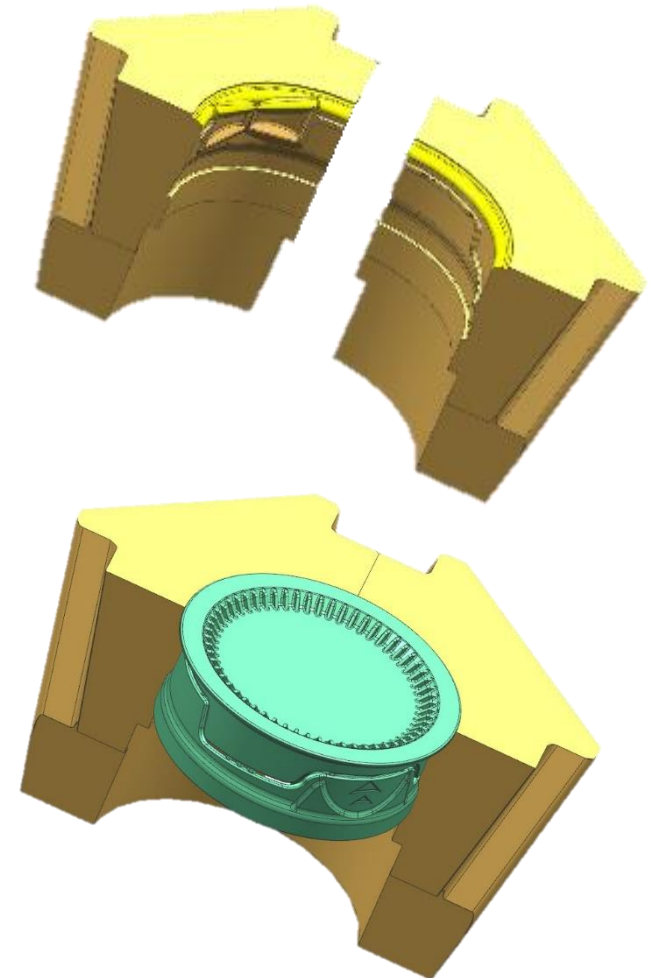

HIGHEST FLEXIBILITY IN THE MARKET

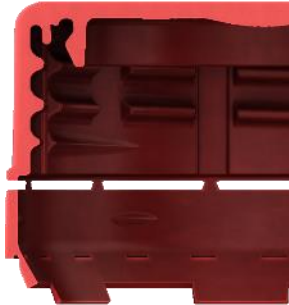

z-folded®

- ✓ SAME MOULD SIZE AND CAVITY PITCH
- ✓ SAME HOT RUNNERS



z-slides®

- ✓ MOSTLY SAME MOULD PLATES
- ✓ SAME MOULD ACCESSORIES



z-slides® extended

- ✓ SAME COOLING SYSTEM
- ✓ MOSTLY SAME STANDARD PARTS



ANYTHING ELSE?

WHAT SOLUTION ARE YOU LOOKING FOR?



We can offer different lightweight and/or tethered solutions, specially matched to your specific requirements.

Doesn't matter what you use today and how your production is running, it's always interesting to discuss with us further optimization potentials.

At z-moulds you can always talk directly to the experts.



Lightweight 1-piece Sportscaps



Lightweight 2-piece Sportscaps



Tethered Cap for existing 29/25 threaded neck

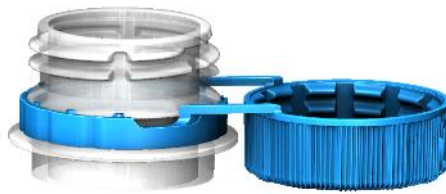

Classical tethering lasso solutions



Tethered Caps with hinge solutions



Lightweight Edible Oil caps

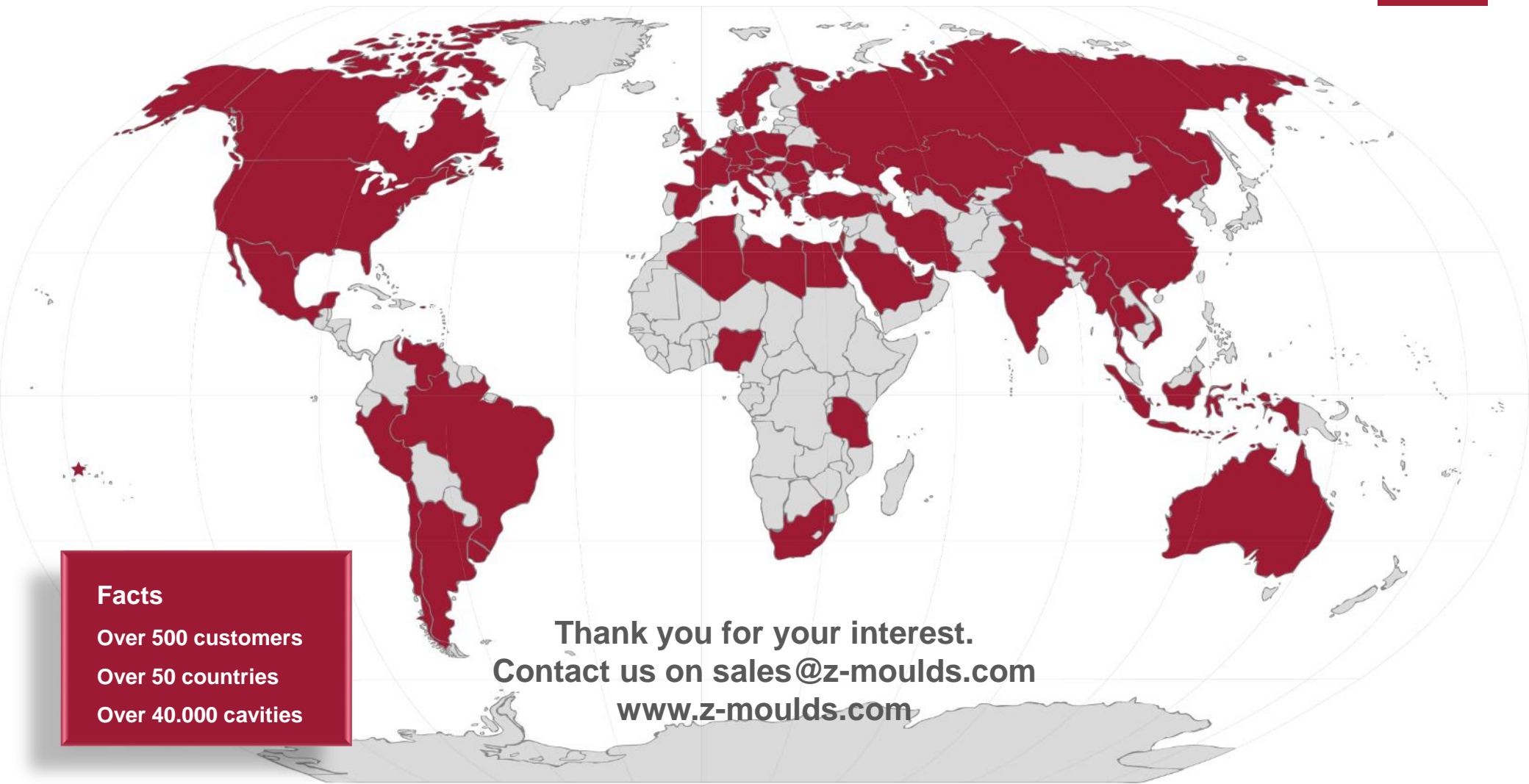

Facts

Over 500 customers

Over 50 countries

Over 40.000 cavities

**Thank you for your interest.
Contact us on sales@z-moulds.com
www.z-moulds.com**